

TAF-175-60-12-14 -- Square Shaft 1-3/4" RCS Lead Section

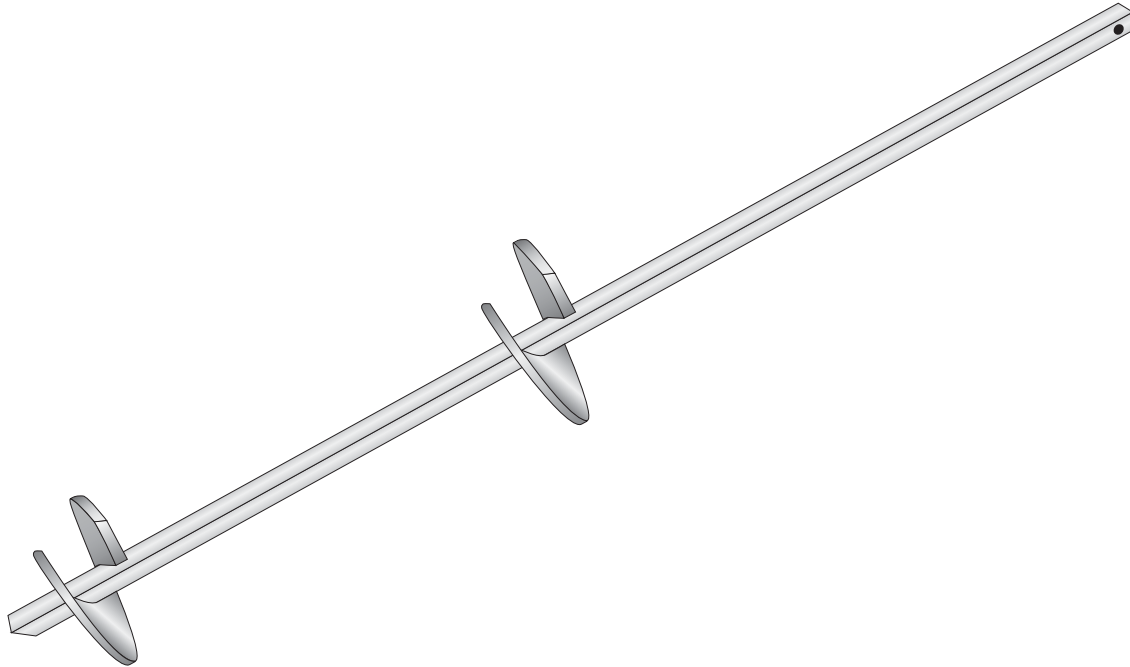

Product Specifications

Anchor Style	Square Shaft (175) Anchor
Component	Lead Section
Number of Helices	2
Helix Diameter	12" (305 mm) - 14" (356 mm)
Length	60" (1524 mm)
Flight Thickness	3/8" (9.5 mm)
Flight Yield Strength	50,000 lbs (222.4 kN)
Rod Tensile Strength	100,000 lbs (444.8 kN)
Torque Rating	11,000 Ft Lbs (14,914 N-M)
Coating	Hot-Dip Galvanized
Standard Package	25
Standard Package Unit	EA
Min Order Qty	1
Weight/Ea.	78 lbs
Weight Per Pallet	1950 lbs

Notes

Square Shaft (175) Lead Section, 60" Length (1524 mm) long with 12" (305 mm)-14" (356 mm) Helices