

ECP Steel Pier™ - PPB-200 Utility Bracket Pier System

- Ultimate Capacity – 50,000 lb
- Maximum Field Test Load – 37,000 lb
- 64 Square Inches Bearing Surface
- Standard Lift – 4" Max
- Fully Adjustable Lift Capability
- Installs From Outside or Inside Structure
- Friction Reduction Collar On Lead Pier Section
- 2-7/8" Diameter High Strength, Galvanized Tubular Pier
- Installs With Portable Equipment
- Installed With Little or No Vibration
- Installs To Rock or Verified Load Bearing Stratum
- 100% of Piers Field Load Tested During Installation
- Manufacturer's Warranty

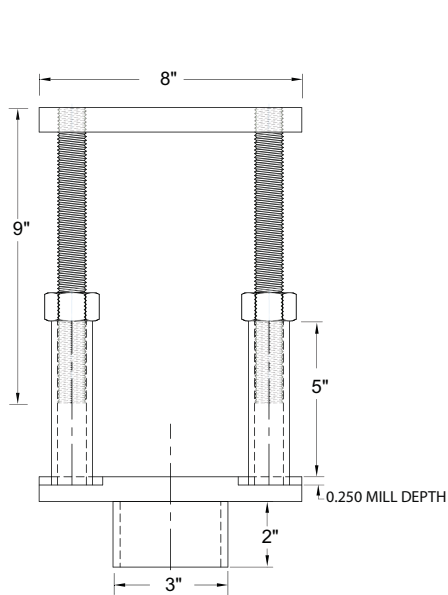

**PPB-200
Utility Bracket Details**

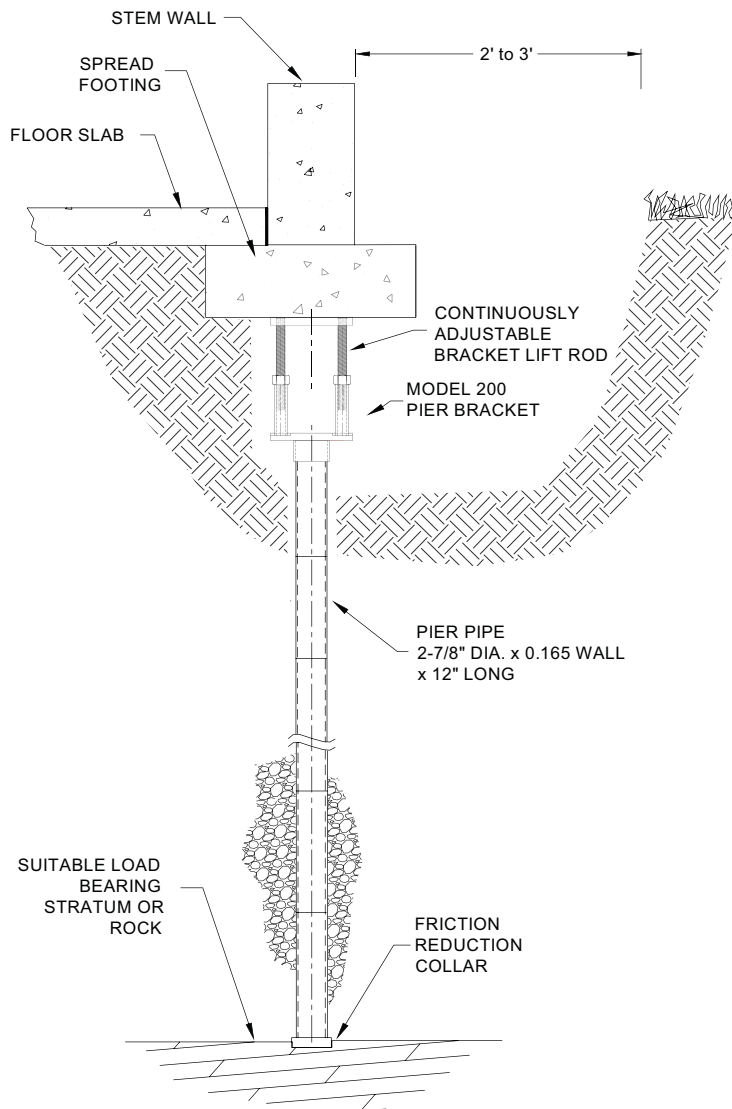

**PPB-200 Utility Bracket
Application Drawing**



© 2015 Earth Contact Products, L.L.C.
Permission granted to copy for sole purpose to prepare bid documents