

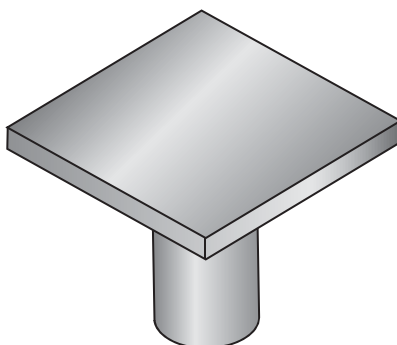

TAB-175-NC - Helical New Construction Pile Cap



Product Specifications

Product Style	Helical New Construction Pile Cap
Component	TAB-175-NC New Construction Pile Cap
Ultimate Capacity Compression	70 Kips
Material	A36
Length	8"
Width	8"
Max Lift	3/4"
Coating	Galvanized or Black
Standard Package	1
Weight	9 lbs

Notes

Used with TA-175 helicals.